









1 rok ca 29 kvm

Fiskare Karlssons gård Hus 1C

FÖRKLARINGAR

-  Spishäll
-  Kyl / Frys
-  Högsåp
-  Städsåp
-  Garderob
-  Linnesåp
-  Kombimaskin
-  Vattenfördelarsåp
-  El central

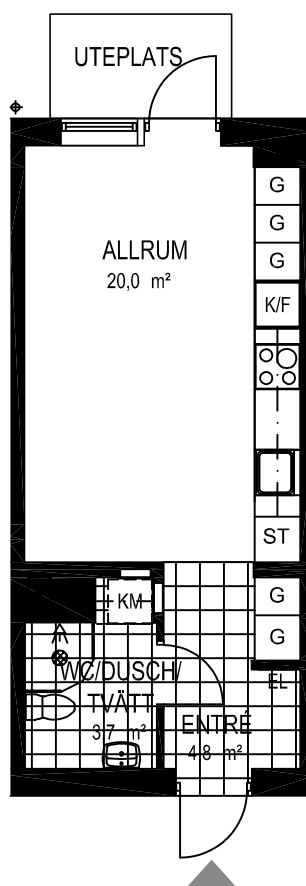



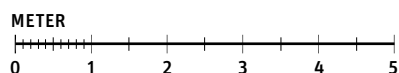
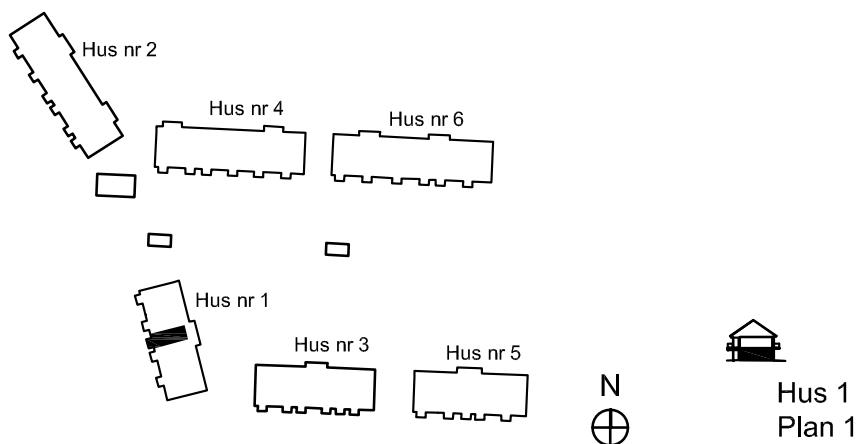





SITUATIONSPLAN



1 rok ca 29 kvm

Fiskare Karlssons gård
Hus 1G-1103

FÖRKLARINGAR

-  Spishäll
-  Kyl / Frys
-  Högskep
-  Städskep
-  Garderob
-  Linneskep
-  Kombimaskin
-  Vattenfördelarskep
-  El central

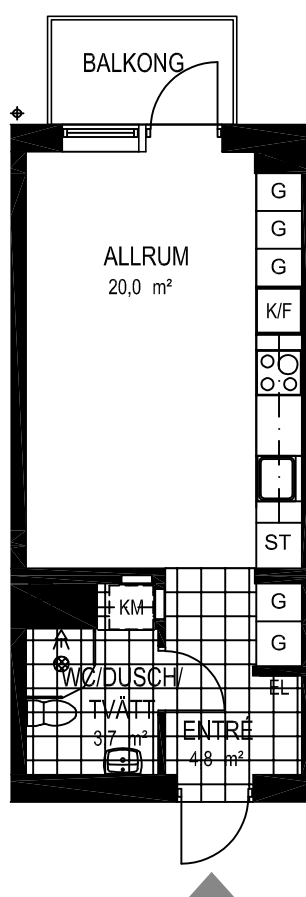



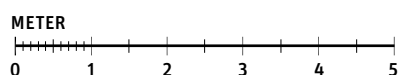
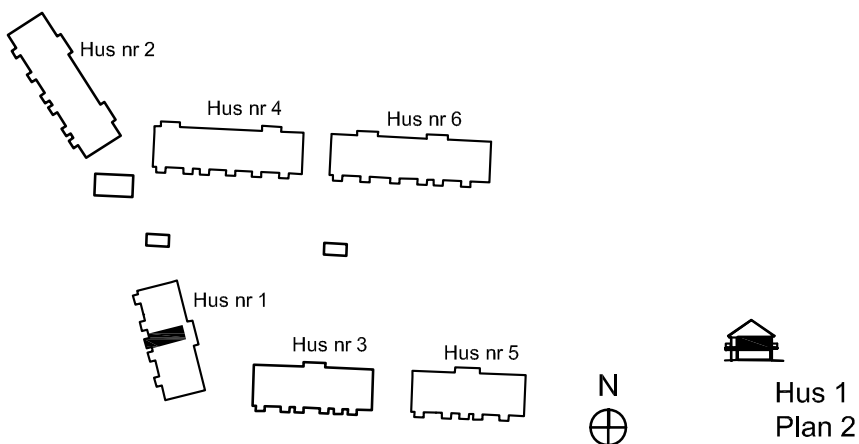





SITUATIONSPLAN



2 rok ca 42 kvm

Fiskare Karlssons gård Hus 1D-1103

FÖRKLARINGAR

-  Spishäll
-  Kyl / Frys
-  Högskep
-  Städskep
-  Garderob
-  Linneskep
-  Kombimaskin
-  Vattenfördelarskep
-  El central

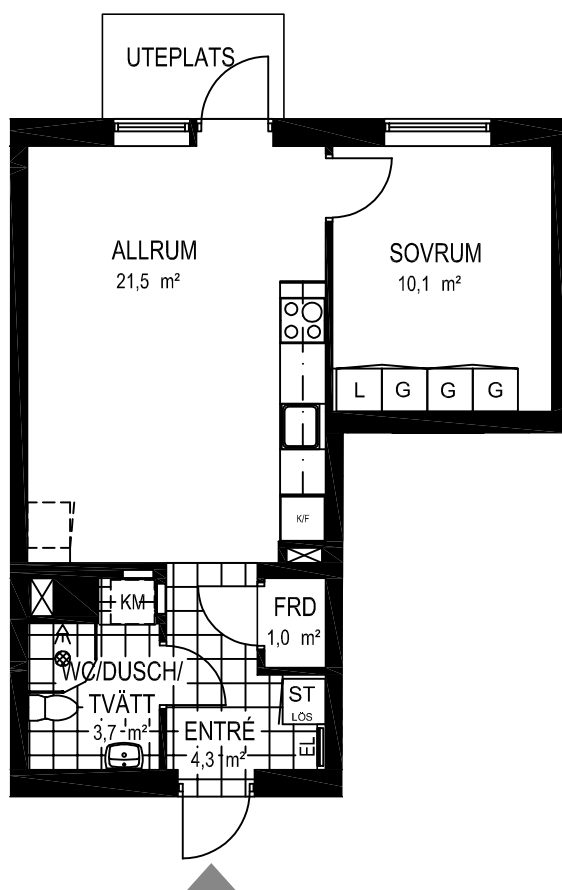



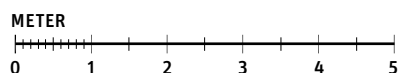
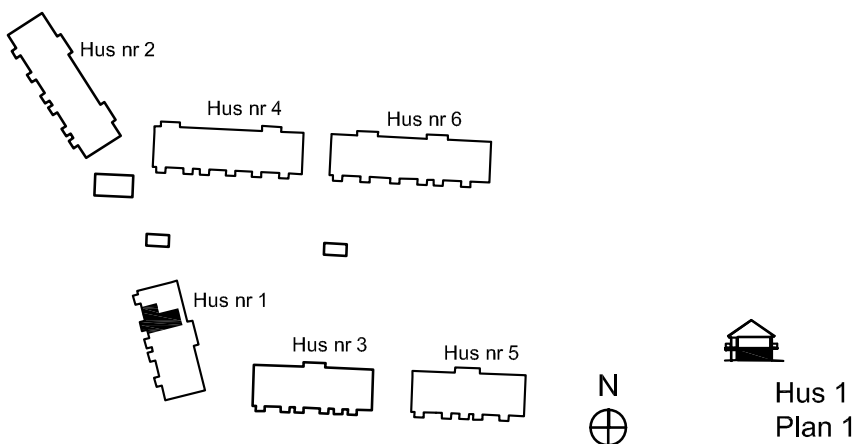





SITUATIONSPLAN



2 rok ca 42 kvm

Fiskare Karlssons gård Hus 1G-1104

FÖRKLARINGAR

-  Spishäll
-  Kyl / Frys
-  Högskep
-  Städskep
-  Garderob
-  Linneskep
-  Kombimaskin
-  Vattenfördelarskep
-  El central

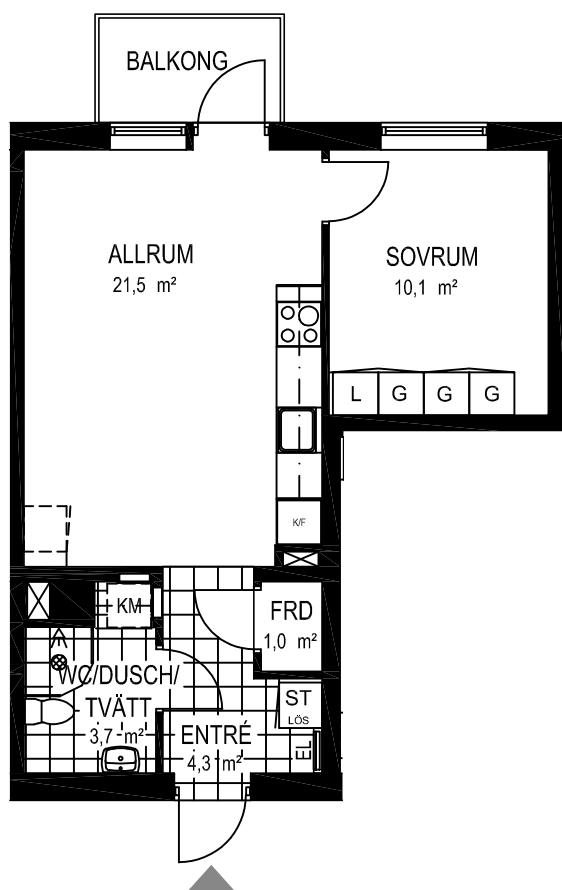



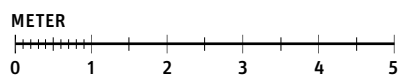
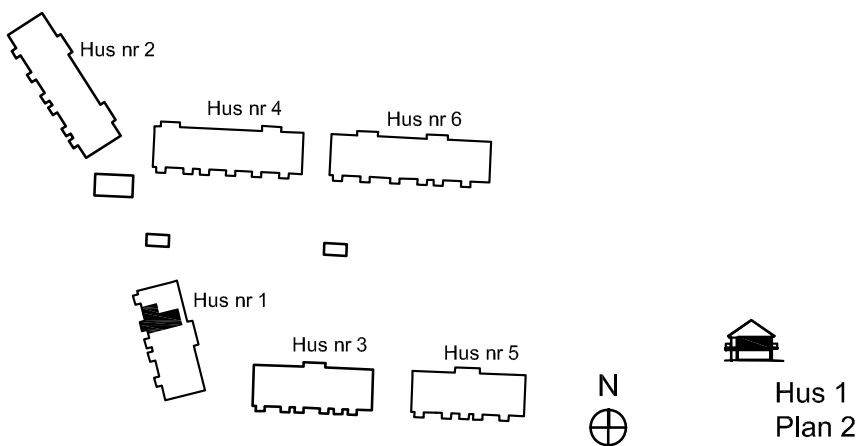





SITUATIONSPLAN



2 rok ca 44 kvm

Fiskare Karlssons gård Hus 1E

FÖRKLARINGAR

-  Spishäll
-  Kyl / Frys
-  Högsåp
-  Stådsåp
-  Garderob
-  Linnesåp
-  Kombimaskin
-  Vattenfördelarsåp
-  El central

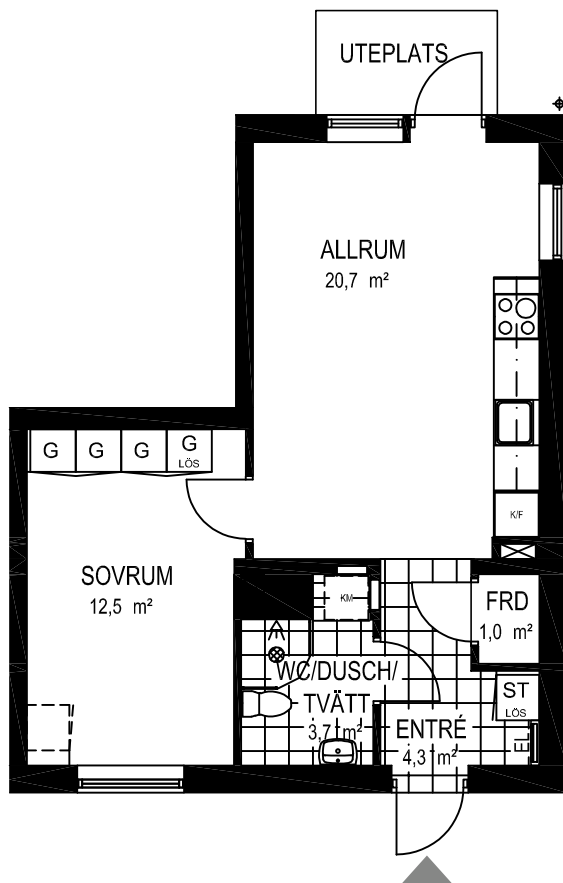



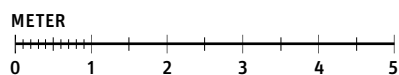
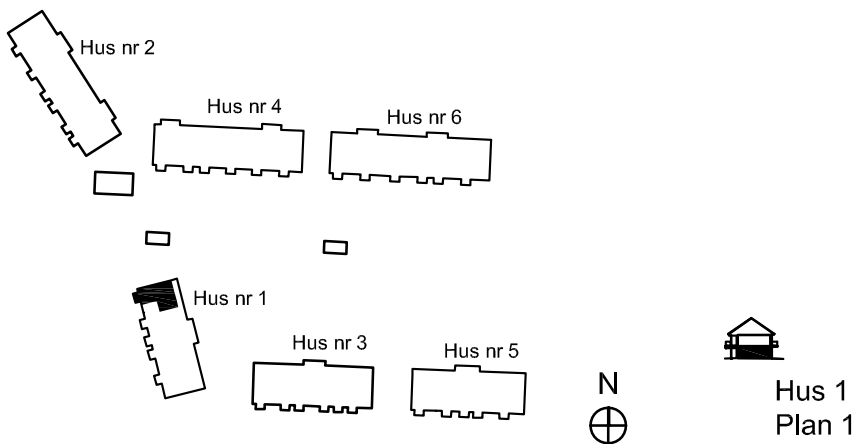





SITUATIONSPLAN



2 rok ca 44 kvm

Fiskare Karlssons gård Hus 1G-1105

FÖRKLARINGAR

-  Spishäll
-  Kyl / Frys
-  Högsåp
-  Städsåp
-  Garderob
-  Linnesåp
-  Kombimaskin
-  Vattenfördelarsåp
-  El central

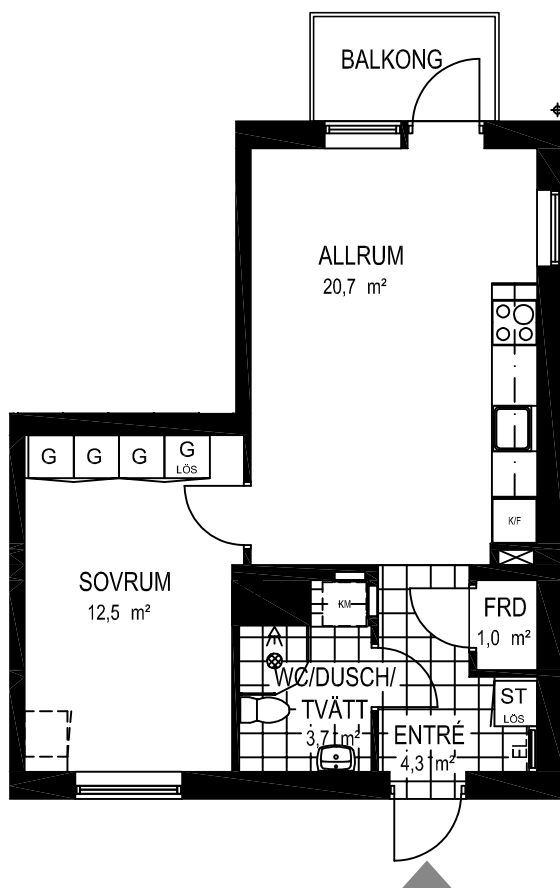

SITUATIONSPLAN

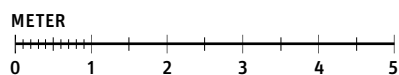
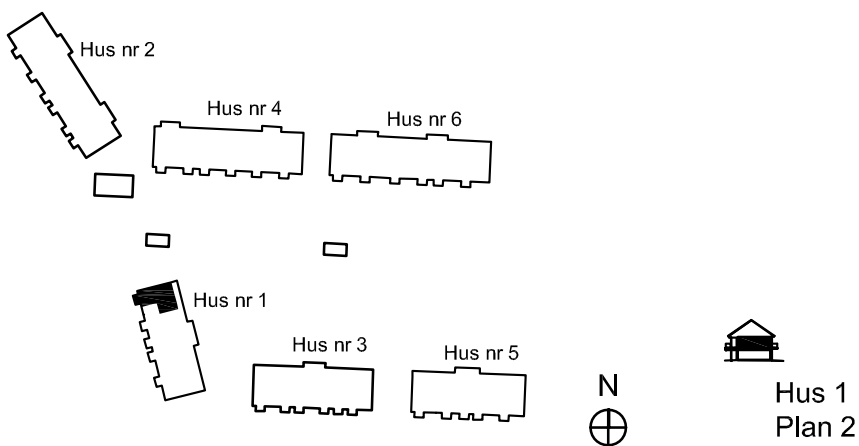

2 rok ca 53 kvm

Fiskare Karlssons gård Hus 1A

FÖRKLARINGAR

-  Spishäll
-  Kyl / Frys
-  Högsåp
-  Städsåp
-  Garderob
-  Linnesåp
-  Tvättmaskin
-  Torktumlare
-  Vattenfördelarsåp
-  El central

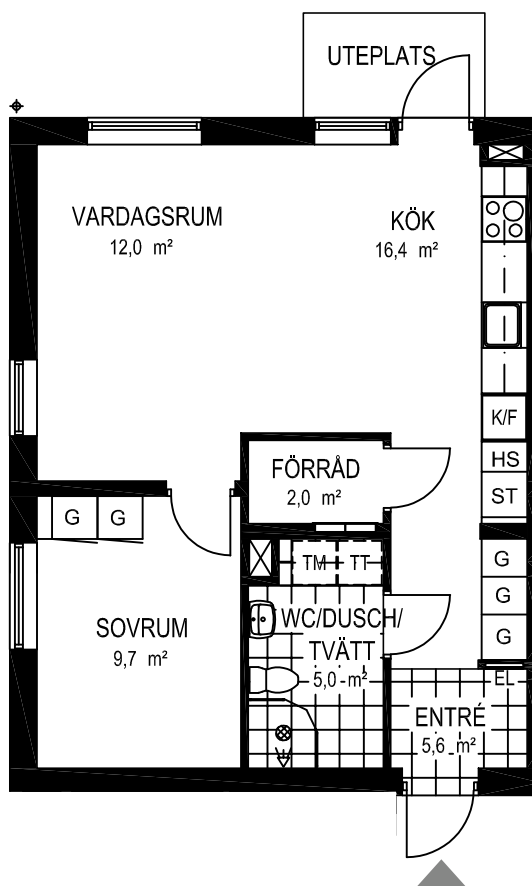

SITUATIONSPLAN

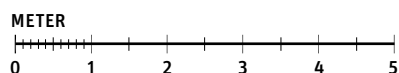
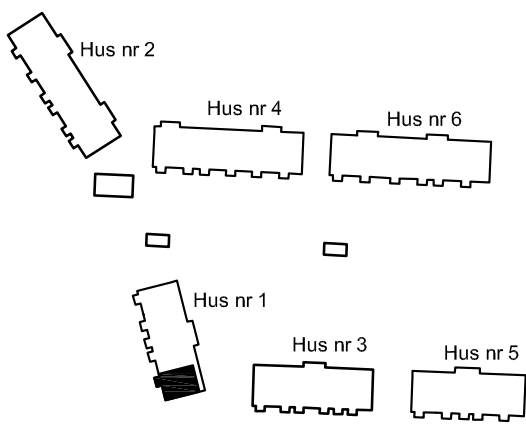

2 rok ca 53 kvm

Fiskare Karlssons gård Hus 1B

FÖRKLARINGAR

-  Spishäll
-  Kyl / Frys
-  Högskep
-  Städskep
-  Garderob
-  Linneskep
-  Tvättmaskin
-  Torktumlare
-  Vattenfördelarskep
-  El central

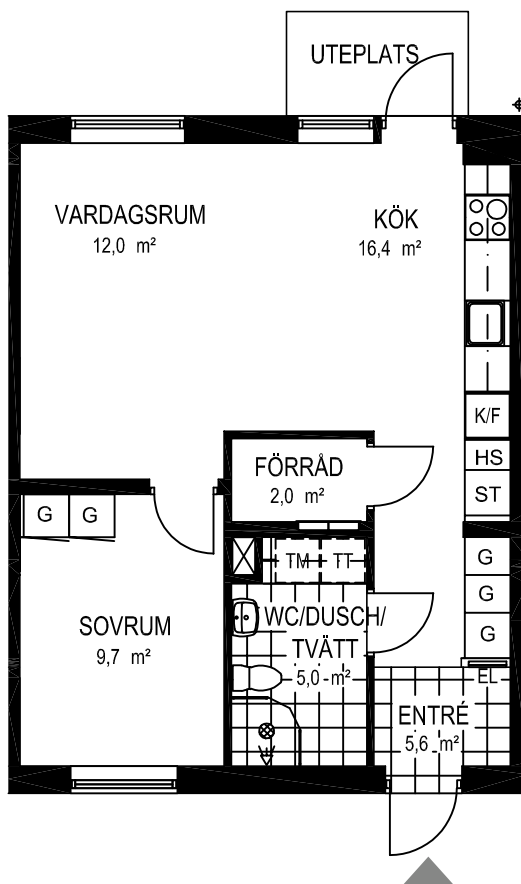

SITUATIONSPLAN

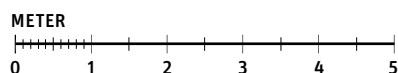
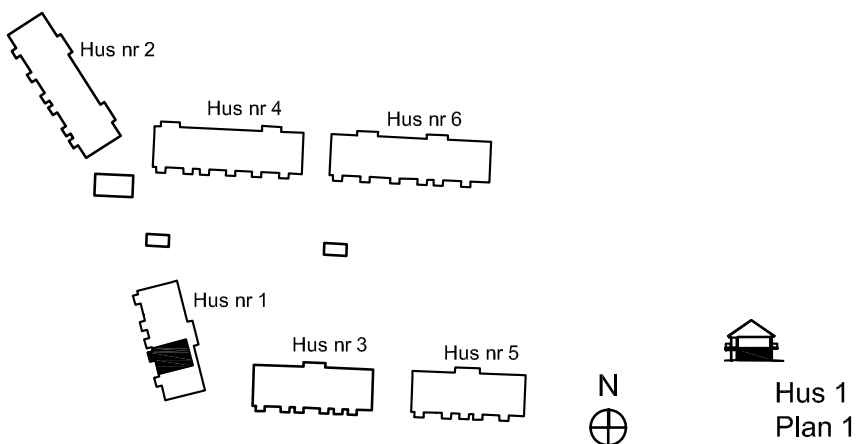

2 rok ca 53 kvm

Fiskare Karlssons gård
Hus 1G-1101

FÖRKLARINGAR

-  Spishäll
-  Kyl / Frys
-  Högsåp
-  Stådsåp
-  Garderob
-  Linnesåp
-  Tvåttmaskin
-  Torktumlare
-  Vattenfördelarsåp
-  El central

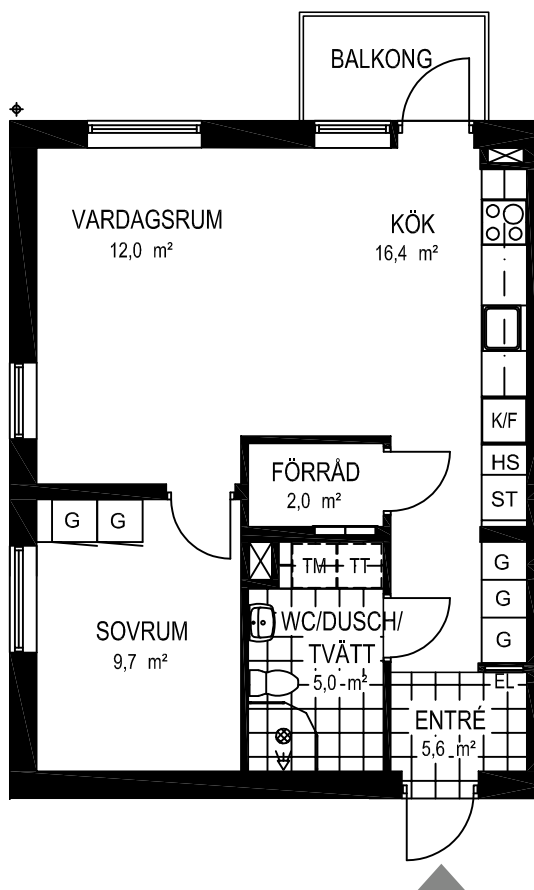

SITUATIONSPLAN

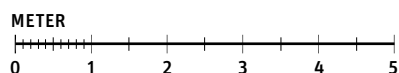
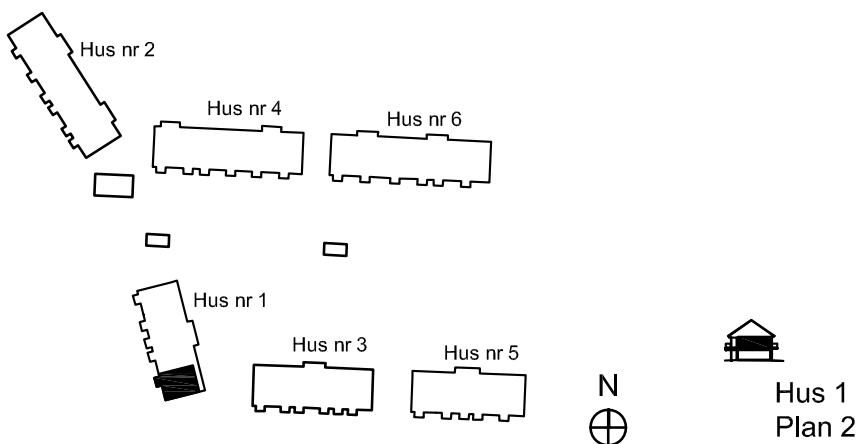

2 rok ca 53 kvm

Fiskare Karlssons gård
Hus 1G-1102

FÖRKLARINGAR

-  Spishäll
-  Kyl / Frys
-  Högsåp
-  Stådsåp
-  Garderob
-  Linnesåp
-  Tvåttmaskin
-  Torktumlare
-  Vattenfördelarsåp
-  El central

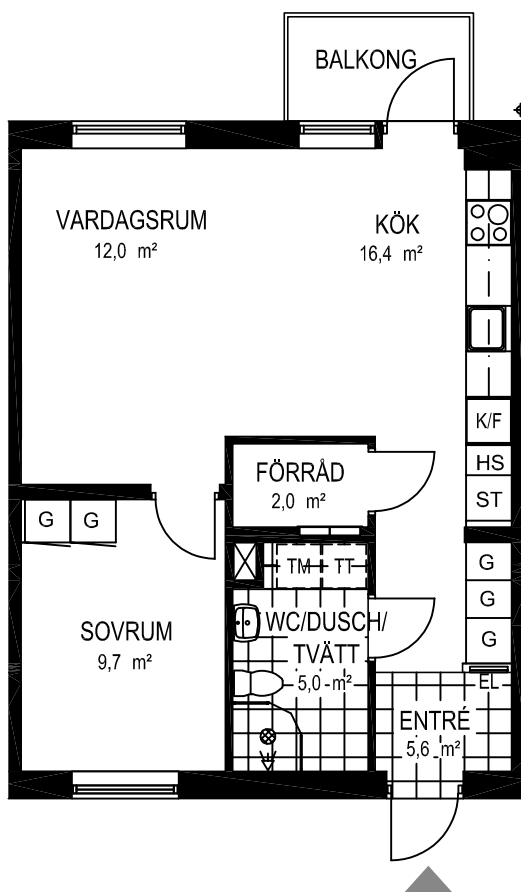

SITUATIONSPLAN

